

Physics of Optoelectronic Devices

Light-Emitting Diodes

This section deals with the principles and characteristics of the technically most important types of visible emitters which are formed, without special lateral structures, as whole-area emitters.

Materials for LEDs

The materials for light-emitting diodes in the visible spectrum (400 - 700 nm) are semiconductors with bandgaps between 1.8 and 3.1 eV, with E_g (eV) = $h\nu = 1240 / \lambda$ (nm). In order to permit effective recombination, the materials should have direct band-to-band transitions or permit other recombination paths with high efficiency. Neither of these requirements are fulfilled by the well-known semiconductors silicon and germanium, as their bandgaps are too small and they are indirect by nature.

As a further requirement, the materials have to enable manufacturing in the form of monocrystals (volume crystals or at least epitaxial layers) and a sufficiently developed technology must be available for processing.

Element combination from groups III and V of the periodic element system results in semiconducting compounds with bandgaps between 0.18 eV (InSb) and approximately 6 eV (AlN); see figure 1.

I	II	III	IV	V	VI	VII	VIII
H							He
Li	Be	B	C	N	O	F	Ne
Na	Mg	Al	Si	P	S	Cl	Ar
K	Ca Zn	Ga	Ge	As	Se	Br	Kr
Rb	Sr Cd	In	Sn	Sb	Te	J	Xe

III	V			
	N	P	As	Sb
Al	AlN 6.0	AlP 2.45	AlAs 2.15	AlSb 1.65
Ga	GaN 3.4 *	GaP 2.26	GaAs 1.42 *	GaSb 0.73 *
In	InN 1.95 *	InP 1.34 *	InAs 0.36 *	InSb 0.18 *

Figure 1. Periodic system of elements and III-V compounds

For every composition the bandgap is given in eV. Direct semiconductors are denoted by an asterisk. The largest direct bandgaps are found in the group III – nitrides GaN and InN. These nitrides are supercede silicon carbide as semiconducting material for blue light emitting diodes.

Gallium arsenide has a direct bandgap of 1.42 eV and is not only important for light emitting diodes, but is also a significant substrate material.

III–V compounds can form mixed crystals with properties between those of the binary compounds. The most important mixed crystal systems pertaining to LEDs are GaAs–AlAs, GaAs – GaP, InP – GaP – AlP.

The bandgap and the lattice constant of $Ga_{1-x}Al_xAs$ and $GaAs_{1-x}P_x$ are shown in figure 2. The direct region is shown as a solid line and the indirect region as a dashed line. Up to $x = 0.44$ (band gap 1.96 eV), $Ga_{1-x}Al_xAs$ is direct, and the lattice constant changes only slightly over the whole mixture range. The highest direct bandgap for $GaAs_{1-x}P_x$ is 1.99 eV ($x = 0.45$). In the indirect region of $GaAs_{1-x}P_x$, the efficiency of radiating recombination can be increased considerably by doping with nitrogen (isoelectronic center). This reduces the effective bandgap by approximately 0.06 eV (second dashed line).

The bandgaps required for common LED colors are marked at the top of figure 2. Whereas red emission can be achieved with $Ga_{0.6}Al_{0.4}As$ or $GaAs_{0.6}P_{0.4}$ (both direct), the indirect $GaAs_{1-x}P_x:N$ is used for the other colors.

In figure 3, the bandgaps and lattice constants of InGaAlP are presented. In this diagram, binary compounds are shown as points, ternary compounds as lines, and the quaternary mixed crystal InGaAlP as a shaded area. The binary crystals InP, GaP and AlP form the species. Their characteristic form is a result of the complex nature of the band structure and the transition from the direct to the indirect region and vice versa. The diagram shows which InGaAlP compositions are direct and which mixed crystals are lattice matched to a given substrate material. Both are necessary prerequisites for the manufacture of particularly bright light emitting diodes. The vertical dashed line drawn through the direct bandgap region shows the compositions that are exactly lattice matched to, and can be manufactured on a GaAs substrate. The corresponding notation $In_{0.5}(Ga_xAl_{1-x})_{0.5}P$ gives the ratio of the amounts of atoms in the crystal lattice. The bandgap is direct if the aluminium concentration is below $x = 0.7$. The spectral region from red via orange and yellow to green can be covered by variation of x in InGaAlP. Extremely high luminescent efficiencies for orange and yellow are obtained in double heterostructures of InGaAlP situated on a Bragg reflector on a GaAs substrate.

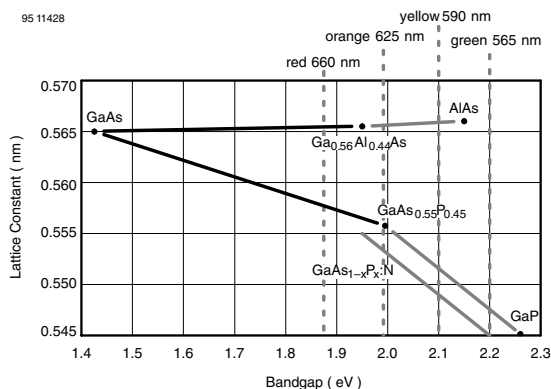

Figure 2. Bandgaps and lattice constants

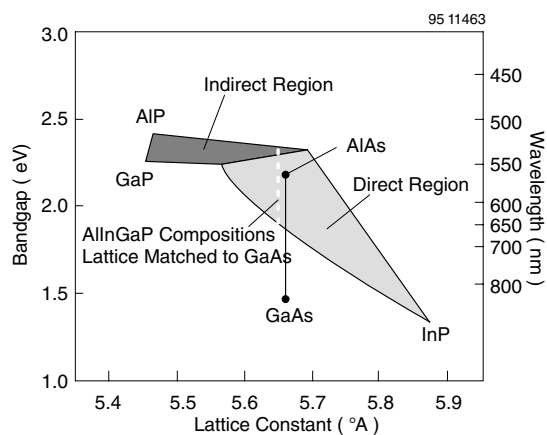

Figure 3. Bandgaps and lattice constants for InGaAlP

Technologies

The figures below show two structures on a GaAs substrate: figure 4, standard red and figure 5, DH-red. Standard red consists of $\text{GaAs}_{0.6}\text{P}_{0.4}$ which was deposited with a $\text{GaAs}_{1-x}\text{P}_x$ buffer layer on a n-GaAs substrate by vaporphase epitaxy. The element is manufactured in a planar process with masked Zn diffusion. The substrate is opaque in this case. This means that the rear contact can be provided over the complete area.

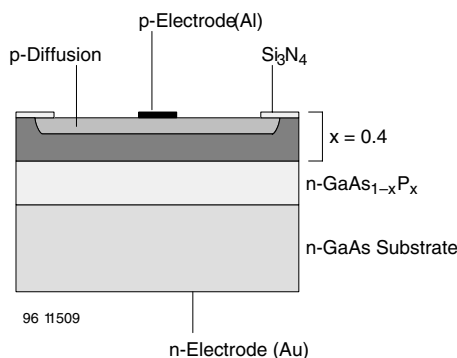

Figure 4. Standard red

The DH-red element consists of three epitaxial layers on p-GaAs substrate. The active layer with 35 % Al content is manufactured between two layers of $\text{Ga}_{1-x}\text{Al}_x\text{As}$ of > 60 % Al content.

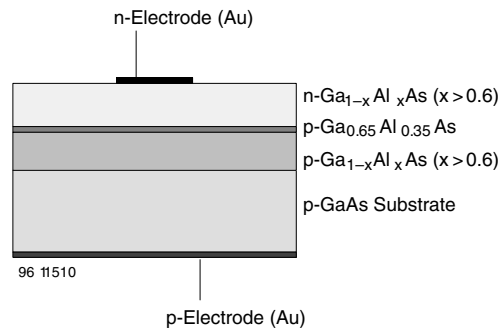

Figure 5. DH-red

Other standard LEDs are shown in figures 6 and 7. The chips for orange and yellow are similar to the standard red type. Due to the large amount of P, 0.6 or 0.85, the material is deposited with suitable buffer layers on the transparent GaP substrate, and a reflective rear contact is provided.

The green element consists entirely of GaP and can therefore be manufactured with liquid-phase epitaxy. The grown PN junction is divided by mesa etching in this example to enable measurement of individual chips on the wafer.

A new type of LED for applications where a particularly high brightness is required is shown in figure 8. The structure is similar to that of a DH-red element. A double heterostructure is arranged on a light-absorbing GaAs substrate. A combination of a Bragg reflec-

tor between the substrate and DH-structure and window layer on the DH-structure effect an extremely high luminescent efficiency in this type of LED.

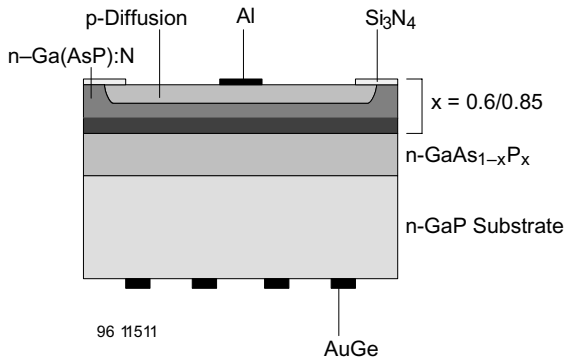

Figure 6. Orange and yellow

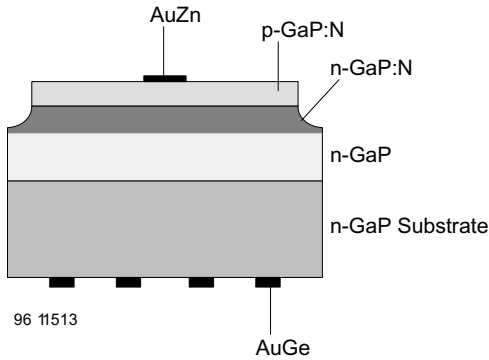

Figure 7. Green

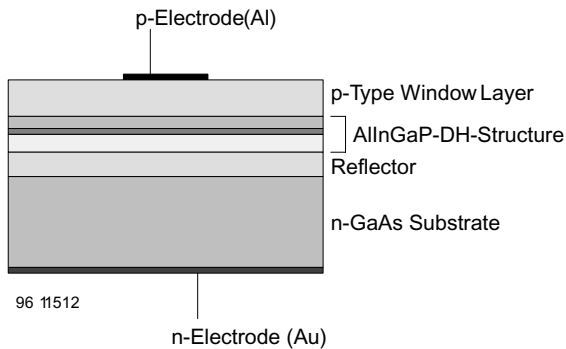

Figure 8. AllnGaP technology

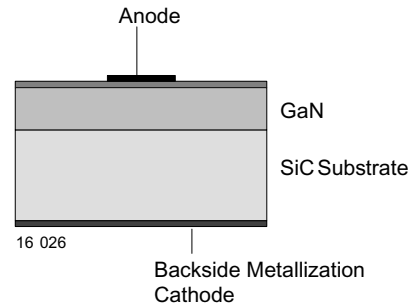

Figure 9. GaN / InGaN / straight wall

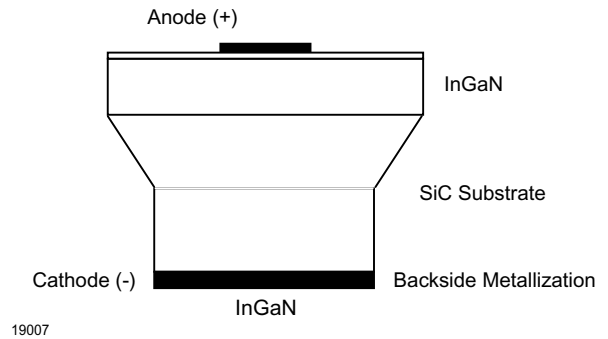

Figure 10. Mushroom shaped

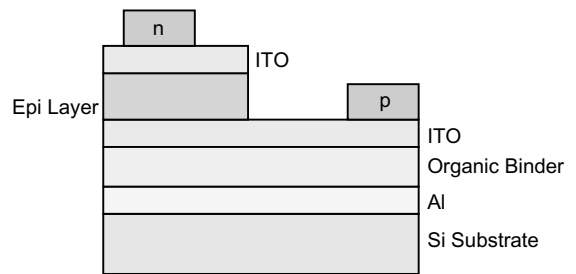

Figure 11. OMA-Chip

LED Characteristics

The most important characteristics of the LEDs dealt with here are summarized in table 1. The emission of LEDs is almost monochromatic and can be characterized by a peak wavelength (column 4) and a spectral half bandwidth (column 6). The lowest spectral half bandwidth is generated by LEDs with direct band-to-band recombination, while other mechanisms and material inhomogeneities lead to wider emission. Here, it is evident that the efficiency drops as the wavelength is reduced.

Liquid-phase elements generally have a higher efficiency than comparable vapor-phase elements. For applications in which a Si detector is to be used as a

Vishay Semiconductors

receiver, for example, the emitted radiated power ϕ_e is important. If, however, the receiver is the human eye, the light flux ϕ_v is decisive.

Figure 12 shows the sensitivity of the human eye in accordance with DIN 5031. The maximum value is 683 lm/W at 555 nm. Green LEDs are close to this maximum value, while the curve for red emission drops rapidly. An orange LED (630 nm), for example, appears approximately 5 times brighter than a red LED (660 nm) at the same efficiency.

White LED

In general white light is a mixture of the 3 basic colors red, green and blue. A cost effective solution is white light out of only one chip by using the physical principle of luminescence conversion. A high brightness InGaN-based LED chip, mounted in the reflector cup is covered by a luminescence converter consisting of an inorganic phosphor material dissolved in Silicon, while the whole system is embedded in transparent epoxy resin. Part of the blue light is absorbed by a TAG-Phosphor converter and emitted at a longer wavelength. The complementary colors blue and yellow mix to form white.

Due to the rapid current rise in the forward direction, LEDs are always connected in series with a current limiting element.

Figure 13 shows how the working point is set with a series resistor. If the supply voltage varies greatly, a constant current source is used. Digital displays and similar devices are often operated in multiplex mode. The seven data lines carry the information for the digits in a time-staggered manner. Each LED is operated for one-quarter of the time with four times the current in order to achieve the same intensity as in continuous operation. In displays with larger numbers of LEDs, it is advisable to reduce the number of driver stages and connecting leads. Due to the diode characteristics of LEDs, a large number of LEDs can be operated with only a few leads if the circuit is designed accordingly.

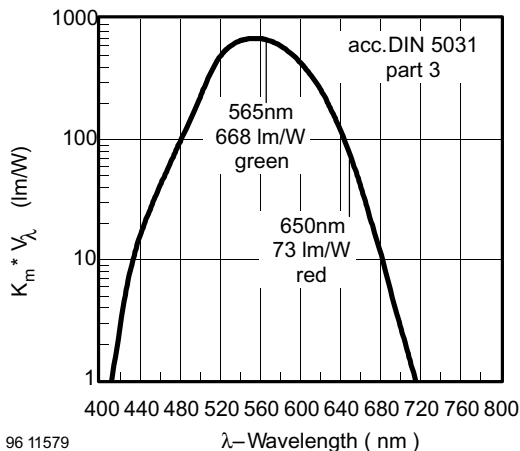
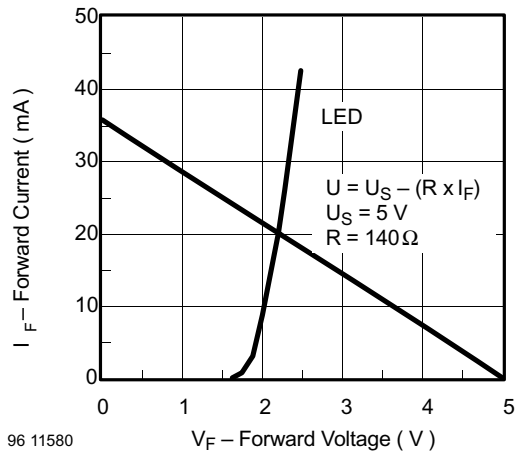

Figure 12. Human eye sensitivity diagram

Electrically, LEDs are ordinary PN diodes (except for GaN). The most important parameter for normal operation is the forward voltage V_F . (Table 1, third column from the right) where the numerical value in V corresponds approximately to the bandgap of the semiconductor used. The speed of LEDs is characterized by their switching times (last columns); red LEDs made of direct materials are fastest, while indirect types are considerably slower due to the special recombination mechanism. Generally, LEDs are robust and their lifetimes (more than 10^5 hours) are more than sufficient for practically all applications.



Vishay Semiconductors

Color	Technology	lp	ld	DI	fv	fe	V _F	t _r	t _f	Efficiency*
		nm	nm	nm	mlm	mW	V	ns	ns	lm/W
Red	GaAlAs on GaAs	650	648	20	60	0.82	1.80	100	100	3.3
Red	GaAsP on GaP	635	620	38	30	0.20	2.00	300	150	1.5
Red	AllnGaP on GaAs	643	630	15	200	1.22	1.85	45	30	10.8
Red	AllnGaP on GaAs	620	618	20	400	1.5	1.85	45	30	21.6
Red (OMA)	AllnGaP on Si	622	615	18	600	2.5	2.8	45	30	28
Softorange	AllnGaP on GaAs	610	605	17	400	1.2	1.90	45	30	21.1
Softorange	GaAsP on GaP	610	605	36	25	0.06	2.00	300	150	1.3
Yellow	AllnGaP on GaAs	590	588	20	200	0.78	1.90	45	30	21.1
Yellow	GaAsP on GaP	585	590	38	30	0.05	2.00	300	150	1.5
Yellow Green	AllnGaP on GaAs	574	572	20	80	1.12	2.0	45	30	4
Green	GaP on GaP	565	570	38	35	0.05	2.00	450	200	1.8
Pure Green	GaP on GaP	555	560	22	12	0.02	2.00	450	200	0.6
Pure Green	AllnGaP on GaAs	561	562	20	30	0.05	2.00	45	30	1.5
True Green	InGaN on SiC	518	523	35	250	0.55	3.10	30	30	8.1
Blue Green	InGaN on SiC	503	505	30	200	0.79	3.20	30	30	6.3
Blue	InGaN on SiC	463	470	25	75	1.21	3.60	30	30	2.1
Blue	GaN on SiC	428	466	65	25	0.96	3.70	30	30	0.7
White	InGaN/TAG on SiC	5500K x=0.33 / y=0.33		not defined	220	1.21	3.60	30	30	6.1

Table 1: Typical technology characteristics @ I_F = 10 mA

*This table gives an overview comparison for all major Vishay technologies. Some LED datasheets might state minor differences.

Conversion Tables

Definition	Radiometry			Photometry		
		Symbol	Unit		Symbol	Unit
Power	Radiant flux (radiant power)	Φ _e	Watt, W	Luminous flux (luminous power)	Φ _v	Lumen, lm
Output power per unit area	Radiant emittance/exittance	M _e	W/m ²	Luminous exitance	M _v	lm/m ²
Output power per unit solid angle	Radiant intensity	I _e	W/sr	Luminous intensity	I _v	candela, cd
Output power per unit solid angle and unit emitting area	Radiance	L _e	W/m ² ·sr	Luminance	L _v	cd/m ² lx = lm/m ²
Input power per unit area	Irradiance	E _e	W/m ²	Illuminance	E _v	Lux, lx
Energy	Radiant energy	Q _e	Ws	Luminous energy (quantity of light)	Q _v	lm * s
Energy per unit area	Radiant exposure (irradiation)	H _e	(W*s)/m ²	Light exposure	H _v	(lm*s)/m ²

Table 2: Corresponding radiometric and photometric, symbols and units

Unit	cd * m ⁻²	asb	sb	L	cd * ft ⁻²	fL	cd * in ⁻²	Notes
1 cd*m ⁻²	1	p	10 ⁻⁴	π*10 ⁻⁴	9.29*10 ⁻²	0.2919	6.45*10 ⁻⁴	
1 asb (Apostilb)	1/p	1	1/π*10 ⁻⁴	10 ⁻⁴	2.957*10 ⁻²	0.0929	2.054*10 ⁻⁴	
1 sb (stilb)	10 ⁴	π*10 ⁴	1	p	929	2919	6.452	
1 L (Lambert)	1/π 10 ⁴	10 ⁴	1/π	1	2.957*10 ²	929	2.054	
1 cd*ft ⁻²	10.764	33.82	1.076*10 ⁻³	3.382*10 ⁻³	1	p	6.94*10 ⁻³	ft = foot
1 fl (Footlambert)	3.426	10.764	3.426*10 ⁻⁴	1.0764*10 ⁻³	1/π	1	2.211*10 ⁻³	
1 cd*in ⁻²	1550	4869	0.155	0.4869	144	452.4	1	in = inch

Table 3: Luminance Conversion Units (DIN 5031 part 3)

Unit	lx	lm * cm ⁻²	fc	Notes
1 lx	1	10 ⁻⁴	0.0929	
1 lm*cm ⁻²	104	1	929	instead of lm*cm ⁻² , formerly Phot (ph)
1 fc (footcandle)	10.764	10.764*10 ⁻⁴	1	

Table 4: Illuminance Conversion Units

Special Notes and Conversion Diagrams

- a) At standard illuminant A:
 $1 \text{ klx} \approx 6.1 \text{ mW/cm}^2$ or $1 \text{ mW/cm}^2 \approx 164 \text{ lx}$
- b) At 555 nm it is valid: $683 \text{ lm}^a = 1 \text{ W}$
 $634.5 \text{ lm/ft}^2 \approx 1 \text{ mW/cm}^2$
- c) $1 \text{ lumen/ft}^2 = 1 \text{ footcandle}$
 $4 \pi \text{ candlepower} = 1 \text{ lumen (lm)}$

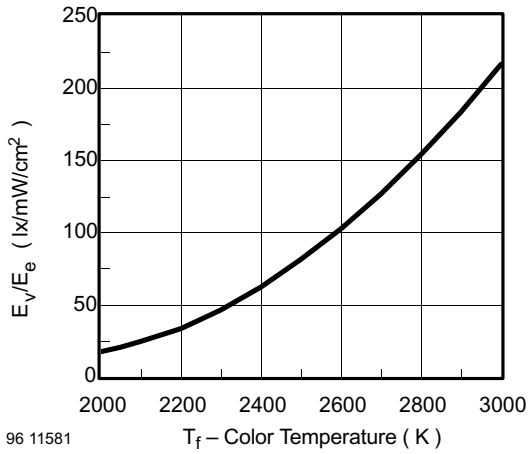

96 11581

Figure 14. $E_v/E_e (T_f)$

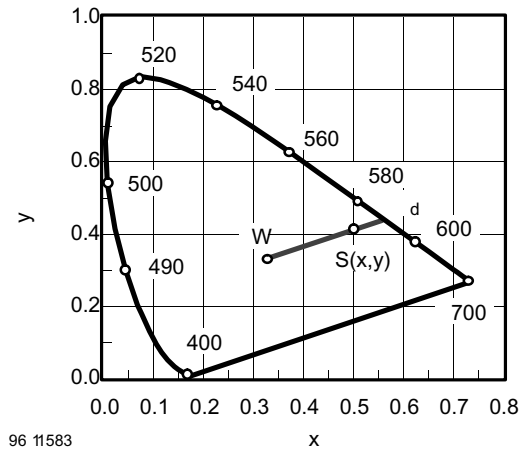

96 11583

Figure 16. Chromaticity diagram acc. to CIE 1931

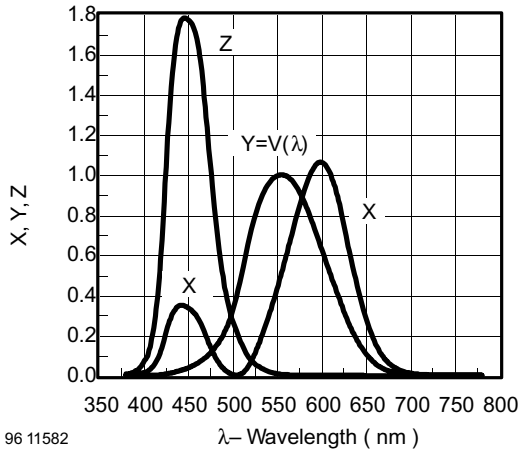

96 11582

Figure 15. Color matching functions acc. to CIE 1931

